

Zieher offers innumerable possibilities to present food optically appealing and highly flexible. When developing new buffet products it is most important for Zieher to guarantee compatibility among the individual systems. The "Zieher-System" with its different heights of 12, 24 and 36 cm or 8, 16, and 24 cm leads to a perfect composition of different presentation levels on the buffet, thus offering a bigger flexibility in the arrangement of a buffet. A wide range of buffet platters and trays of hardened glass, natural slate, laminated plastic and carbon in various styles, are available on pages 54 to 65.

Thanks to the boundless possibilities, varying materials and designs, every buffet can easily be adapted to any accommodation. The system becomes part of the whole interior and assimilates harmonically into any ambiance.

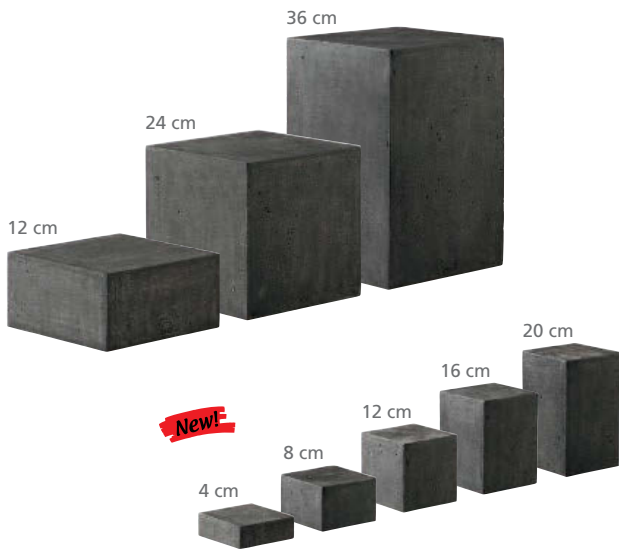

"Bloxx" + "V12" - Carbon



"Konkret!" (from page 46 on)

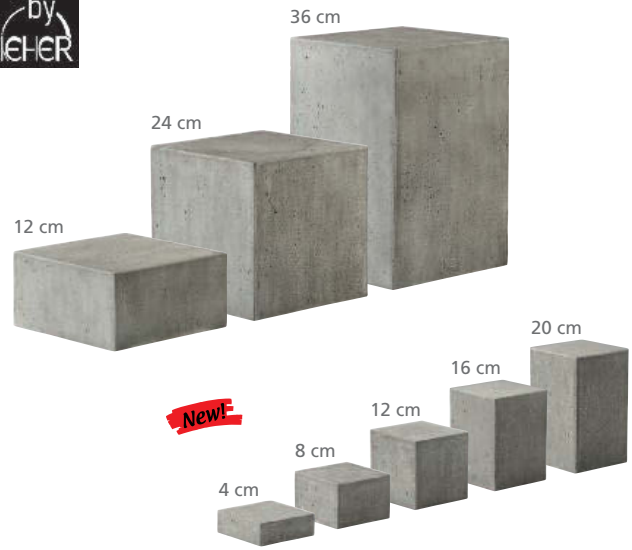

"Konkret!" (from page 46 on)

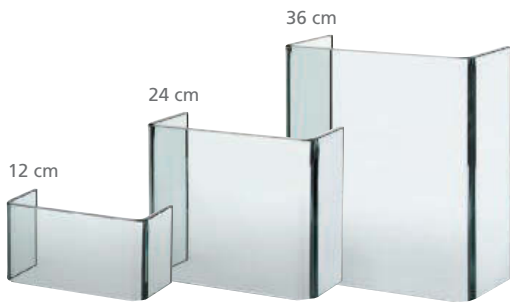

"U-Turn" (page 40)

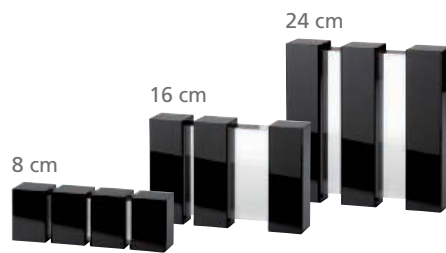

"Bloxx" (from page 50 on)



"Solid" (page 41)

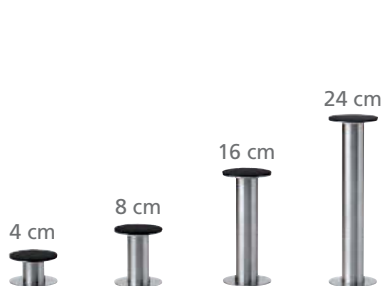

"Basic" (from page 52 on)



"Antique" (page 35)



"Lightning Buffet" (from page 36 on)

The "Zieher-System"

"Basic" + V12" - Carbon



24 cm

New!



24 / 16 / 8 cm

"Classy" (from page 30 on)

16 cm

8 cm



36 cm

8 cm



16 cm

24 cm



"Pearl" (page 34)

New!



"Neo" (from page 32 on)

New!



"Neo" (from page Seite 32 on)

New!



"Neo" (from page 32 on)



"V12" - Carbon (from page 42 on)

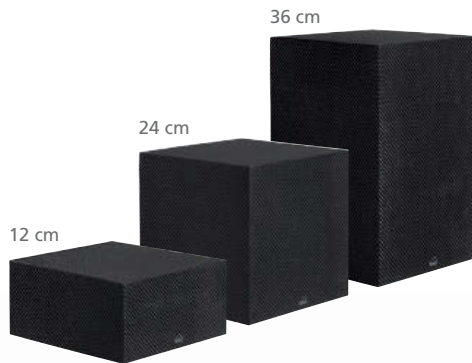

"V12" - Carbon (from page 42 on)

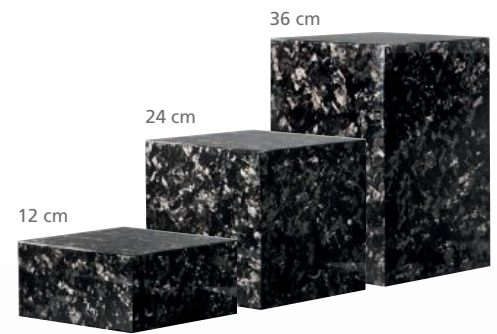

"Carbon 4.0" (from page 43 on)

